



Read and follow these instructions carefully before proceeding with installation. Do not deviate from wiring instructions. Incorrect wiring could cause an electrical short with possible fire. Make sure that wiring is dressed away from moving or hot engine components. If wires run thru drilled holes, protect the wires using grommets and de-burring the holes. Always disconnect battery before making electrical connections. Before re-connecting battery be sure all connections are properly made and soldered.

This instrument is designed to operate on 8 V DC to 32 V DC systems. Hourmeters can be advanced on an actual time basis within the operating voltage range. Hourmeters can not be reset to zero hours.

Hourmeters read maximum 99999.9 hours.

Illumination is not available.

Various standard making organization have established guide lines for wiring colors. Those applicable to your installation should be followed.

Install Gauge in dash.

Installez la jauge dans le tableau de bord.
Messinstrument ins Armaturenbrett einbauen.
Installare lo strumento di misurazione nel quadro degli strumenti.
Instale el medidor en el tablero de instrumentos

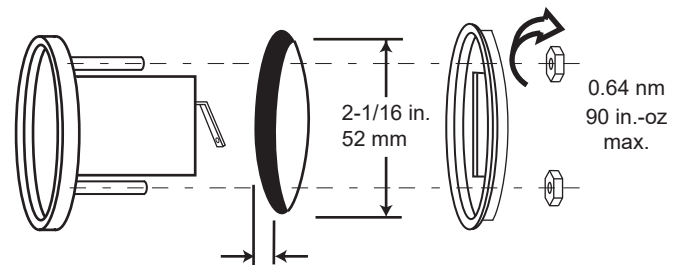

A		B		Ø	
52.5 mm	2 1/16 in.	56.3 mm	2.22 in.	54 mm	2 1/8 in.
86 mm	3 3/8 in.	87.3 mm	3.44 in.	87 mm	3 13/32 in.
110 mm	4 9/32 in.	117.3 mm	4.62 in.	111 mm	4.3/8 in.

Select location	Check for clearance	Drill Hole
Choisir l'emplacement	Vérifiez le dégagement	Forer le trou
Platzierung auswählen	Auf Abstand achten	Loch bohren
Scegliere la posizione	Controllare lo spazio disponibile	Fare un foro
Escoja la ubicación	Verifique el espacio libre	Taladre el orificio

Install Gauge in dash.

Installez la jauge dans le tableau de bord.
Messinstrument ins Armaturenbrett einbauen.
Installare lo strumento di misurazione nel quadro degli strumenti.
Instale el medidor en el tablero de instrumentos

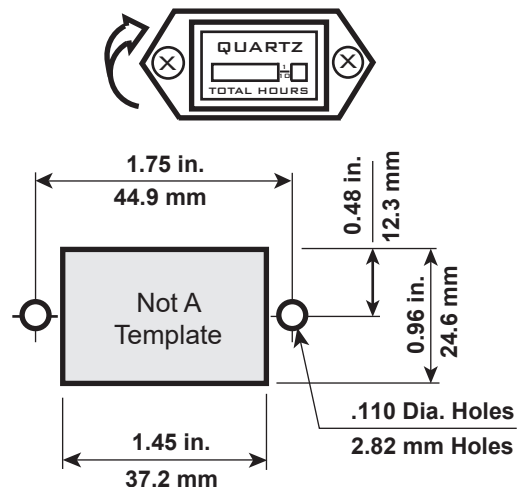

Included

Inclus
Mit eingeschlossen
Inclusi
Includido

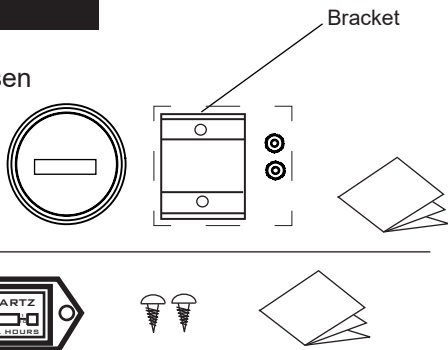

Disconnect Battery



Débrancher la batterie
Batterie abklemmen

Scollegare la batteria
Desconecte la batería

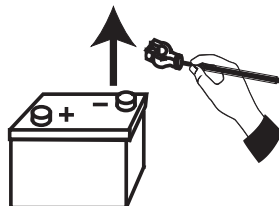

Wiring

Installation électrique
Verdrahten
Cablaggio
Alambrado

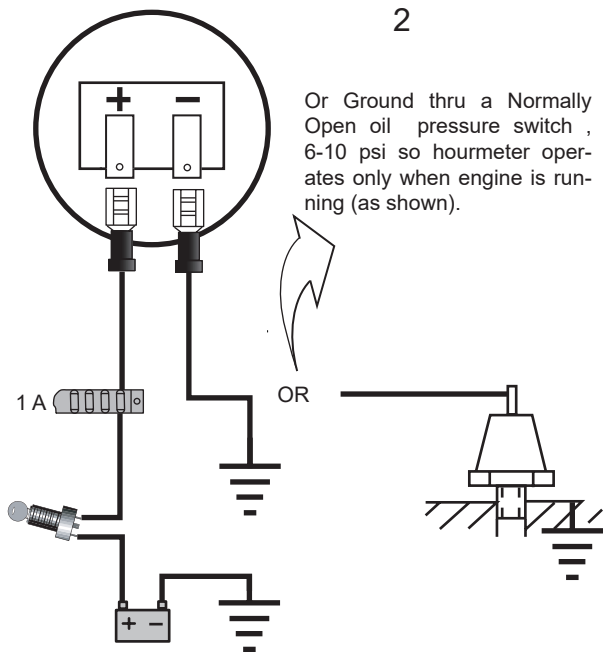
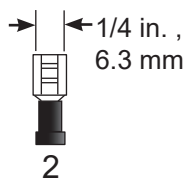

Reconnect Battery



Rebrancher la batterie
Batterie wieder anschließen.

Ricollegare la batteria
Conecte de nuevo la batería

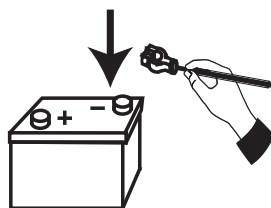

Trouble Shooting

Résolution des problèmes
Fehlerbehebung
Ricerca e Soluzione di Problemi e Guasti
Localización y solución de problemas

Be certain all connections are correct.

Be certain all connections are clean and tight.

Be certain the fuse is not blown.

Depending on the hourmeter you have, you should hear the hourmeter indexing every 3.6 seconds or every 36 seconds. If you hear the sound but the index wheel is not rotating, try loosening the mounting nuts a bit to assure it is not causing a binding.

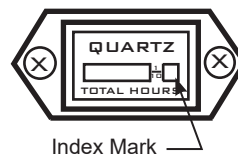

Hours already entered on the hourmeter CAN NOT be removed.

Hours can be added by connecting to a battery and running until the desired hours are achieved.

USA Sales/Support
Veethree Electronics and Marine
2050 47th Terrace East
Bradenton, FL 34203 USA
Tel 941-538-7775
Fax 941-775-1222
techservice@veethree.com
www.veethree.com